

# Dell™ XPS™ L511z Service Manual

Regulatory model: P12F series

Regulatory type: P12F001



# Notes, Cautions, and Warnings



**NOTE:** A NOTE indicates important information that helps you make better use of your computer.



**CAUTION:** A CAUTION indicates potential damage to hardware or loss of data if instructions are not followed.



**WARNING:** A WARNING indicates a potential for property damage, personal injury, or death.

---

**Information in this document is subject to change without notice.**

**© 2011 Dell Inc. All rights reserved.**

Reproduction of these materials in any manner whatsoever without the written permission of Dell Inc. is strictly forbidden.

Trademarks used in this text: Dell™, the DELL logo, and XPS™ are trademarks of Dell Inc.; Microsoft®, Windows® and the Windows start button logo  are either trademarks or registered trademarks of Microsoft corporation in the United States and/or other countries; Bluetooth® is a registered trademark owned by Bluetooth SIG, Inc. and is used by Dell under license.

Other trademarks and trade names may be used in this document to refer to either the entities claiming the marks and names or their products. Dell Inc. disclaims any proprietary interest in trademarks and trade names other than its own.

Regulatory model: P12F series

Regulatory type: P12F001

2011 - 04

Rev. A00

# Contents

1	Before You Begin . . . . .	9
	<b>Recommended Tools</b> . . . . .	9
	<b>Turning Off Your Computer</b> . . . . .	9
	<b>Before Working Inside Your Computer</b> . . . . .	10
2	Base Cover . . . . .	13
	<b>Removing the Base Cover</b> . . . . .	13
	<b>Replacing the Base Cover</b> . . . . .	15
3	Battery . . . . .	17
	<b>Removing the Battery</b> . . . . .	17
	<b>Replacing the Battery</b> . . . . .	18
4	Memory Module(s) . . . . .	19
	<b>Removing the Memory Module(s)</b> . . . . .	19
	<b>Replacing the Memory Module(s)</b> . . . . .	20
5	Wireless Mini-Card . . . . .	23
	<b>Removing the Mini-Card</b> . . . . .	23

	<b>Replacing the Mini-Card</b> . . . . .	<b>25</b>
<b>6</b>	<b>Hard Drive</b> . . . . .	<b>27</b>
	<b>Removing the Hard Drive</b> . . . . .	<b>27</b>
	<b>Replacing the Hard Drive</b> . . . . .	<b>29</b>
<b>7</b>	<b>Coin-Cell Battery</b> . . . . .	<b>31</b>
	<b>Removing the Coin-Cell Battery</b> . . . . .	<b>31</b>
	<b>Replacing the Coin-Cell Battery</b> . . . . .	<b>32</b>
<b>8</b>	<b>Optical Drive</b> . . . . .	<b>35</b>
	<b>Removing the Optical Drive</b> . . . . .	<b>35</b>
	<b>Replacing the Optical Drive</b> . . . . .	<b>37</b>
<b>9</b>	<b>AC-Adapter Connector</b> . . . . .	<b>39</b>
	<b>Removing the AC-Adapter Connector</b> . . . . .	<b>39</b>
	<b>Replacing the AC-Adapter Connector</b> . . . . .	<b>40</b>
<b>10</b>	<b>Power-Button Board</b> . . . . .	<b>43</b>
	<b>Removing the Power-Button Board</b> . . . . .	<b>43</b>
	<b>Replacing the Power-Button Board</b> . . . . .	<b>44</b>

11	Audio Board	47
	<b>Removing the Audio Board</b>	47
	<b>Replacing the Audio Board</b>	48
12	Battery Status-Light Board	51
	<b>Removing the Battery Status-Light Board</b>	51
	<b>Replacing the Battery Status-Light Board</b>	52
13	Fan	55
	<b>Removing the Fan</b>	55
	<b>Replacing the Fan</b>	56
14	Heat Sink	57
	<b>Removing the Heat Sink</b>	57
	<b>Replacing the Heat Sink</b>	58
15	System Board	61
	<b>Removing the System Board</b>	61
	<b>Replacing the System Board</b>	64
	<b>Entering the Service Tag in the BIOS</b>	65

16 Keyboard . . . . .	67
<b>Removing the Keyboard Bracket . . . . .</b>	<b>67</b>
<b>Replacing the Keyboard Bracket . . . . .</b>	<b>69</b>
<b>Removing the Keyboard . . . . .</b>	<b>69</b>
<b>Replacing the Keyboard . . . . .</b>	<b>70</b>
17 Speakers . . . . .	73
<b>Removing the Speakers . . . . .</b>	<b>73</b>
<b>Replacing the Speakers . . . . .</b>	<b>74</b>
18 Palm-Rest Assembly . . . . .	77
<b>Removing the Palm-Rest Assembly . . . . .</b>	<b>77</b>
<b>Replacing the Palm-Rest Assembly . . . . .</b>	<b>78</b>
19 Display . . . . .	81
<b>Display Assembly . . . . .</b>	<b>81</b>
Removing the Display Assembly . . . . .	81
Replacing the Display Assembly . . . . .	82
<b>Display Bezel. . . . .</b>	<b>83</b>
Removing the Display Bezel . . . . .	83
Replacing the Display Bezel . . . . .	85
<b>Display Panel. . . . .</b>	<b>86</b>
Removing the Display Panel . . . . .	86
Replacing the Display Panel . . . . .	87

<b>Display Hinges</b> . . . . .	<b>88</b>
Removing the Display Hinges . . . . .	88
Replacing the Display Hinges . . . . .	89
<b>20 Camera Module</b> . . . . .	<b>91</b>
<b>Removing the Camera Module</b> . . . . .	<b>91</b>
<b>Replacing the Camera Module</b> . . . . .	<b>92</b>
<b>21 Flashing the BIOS</b> . . . . .	<b>95</b>





# Before You Begin

This manual provides procedures for removing and installing the components in your computer. Unless otherwise noted, each procedure assumes that the following conditions exist:

- You have performed the steps in "Turning Off Your Computer" on page 9 and "Before Working Inside Your Computer" on page 10.
- You have read the safety information that shipped with your computer.
- A component can be replaced or—if purchased separately—installed by performing the removal procedure in reverse order.

## Recommended Tools

The procedures in this document may require the following tools:

- Small flat-blade screwdriver
- Phillips screwdriver
- Plastic scribe
- BIOS executable update program available at [support.dell.com](http://support.dell.com)







## Turning Off Your Computer

 **CAUTION: To avoid losing data, save and close all open files and exit all open programs before you turn off your computer.**

- 1 Save and close all open files and exit all open programs.
- 2 To shut down the operating system, click **Start**  and then click **Shut Down**.
- 3 Ensure that the computer is turned off. If your computer did not automatically turn off when you shut down the operating system, press and hold the power button until the computer turns off.

# Before Working Inside Your Computer

Use the following safety guidelines to help protect your computer from potential damage and to help to ensure your own personal safety.

-  **WARNING:** Before working inside your computer, read the safety information that shipped with your computer. For additional safety best practices information, see the Regulatory Compliance Homepage at [www.dell.com/regulatory\\_compliance](http://www.dell.com/regulatory_compliance).
-  **CAUTION:** To avoid electrostatic discharge, ground yourself by using a wrist grounding strap or by periodically touching an unpainted metal surface (such as a connector on your computer).
-  **CAUTION:** Handle components and cards with care. Do not touch the components or contacts on a card. Hold a card by its edges or by its metal mounting bracket. Hold a component such as a processor by its edges, not by its pins.
-  **CAUTION:** Only a certified service technician should perform repairs on your computer. Damage due to servicing that is not authorized by Dell™ is not covered by your warranty.
-  **CAUTION:** When you disconnect a cable, pull on its connector or on its pull-tab, not on the cable itself. Some cables have connectors with locking tabs; if you are disconnecting this type of cable, press in on the locking tabs before you disconnect the cable. As you pull connectors apart, keep them evenly aligned to avoid bending any connector pins. Also, before you connect a cable, ensure that both connectors are correctly oriented and aligned.
-  **CAUTION:** To avoid damaging the computer, perform the following steps before you begin working inside the computer.
  - 1 Ensure that the work surface is flat and clean to prevent the computer cover from being scratched.
  - 2 Turn off your computer (see "Turning Off Your Computer" on page 9) and all attached devices.
-  **CAUTION:** To disconnect a network cable, first unplug the cable from your computer and then unplug the cable from the network device.
  - 3 Disconnect all telephone or network cables from the computer.
  - 4 Press and eject any installed cards from the Media Card Reader.
  - 5 Disconnect your computer and all attached devices from their electrical outlets.

6 Disconnect all attached devices from your computer.

 **CAUTION: To help prevent damage to the system board, remove the main battery (see "Removing the Battery" on page 17) before working inside the computer.**





7 Remove the battery (see "Removing the Battery" on page 17).

8 Turn the computer top-side up, open the display, and press the power button to ground the system board.

 **CAUTION: Before touching anything inside your computer, ground yourself by touching an unpainted metal surface, such as the metal at the back of the computer. While you work, periodically touch an unpainted metal surface to dissipate static electricity, which could harm internal components.**



## Base Cover

-  **WARNING:** Before working inside your computer, read the safety information that shipped with your computer. For additional safety best practices information, see the Regulatory Compliance Homepage at [www.dell.com/regulatory\\_compliance](http://www.dell.com/regulatory_compliance).
-  **CAUTION:** Only a certified service technician should perform repairs on your computer. Damage due to servicing that is not authorized by Dell is not covered by your warranty.
-  **CAUTION:** To avoid electrostatic discharge, ground yourself by using a wrist grounding strap or by periodically touching an unpainted metal surface (such as a connector on your computer).
-  **CAUTION:** To help prevent damage to the system board, remove the main battery (see "Removing the Battery" on page 17) before working inside the computer.

## Removing the Base Cover

- 1 Follow the instructions in "Before You Begin" on page 9.
- 2 Remove the eight screws that secure the base cover to the palm-rest assembly.
- 3 Using your fingertips, carefully pull the connector bezel to separate it from the base cover.

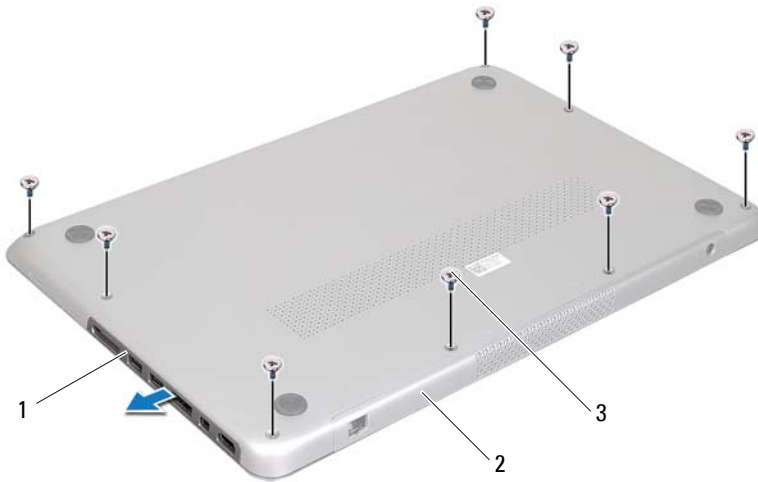

- 1 connector bezel
- 3 screws (8)

- 2 base cover

- 4 Remove the remaining two screws that secure the base cover to the palm-rest assembly.
- 5 Use your fingertips to release the tabs on the base cover from the slots on the palm-rest assembly.
- 6 Lift the base cover off the palm-rest assembly.

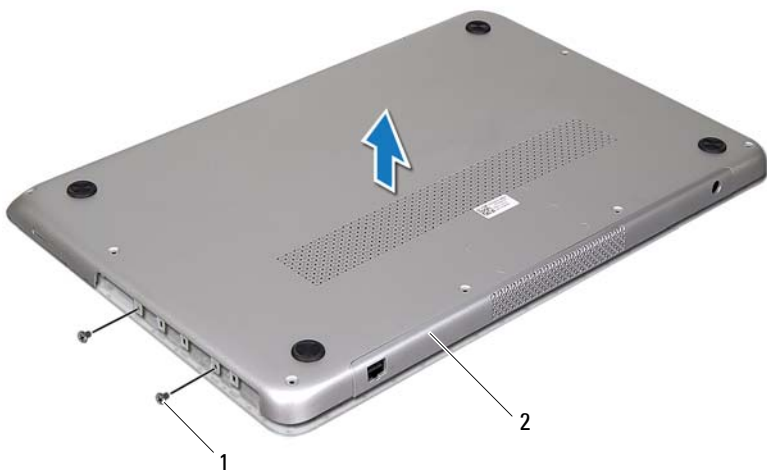

1 screws (2)

2 base cover

## Replacing the Base Cover

- 1 Follow the instructions in "Before You Begin" on page 9.
- 2 Align the tabs on the base cover with the slots on the palm-rest assembly and snap the base cover into place.
- 3 Replace the 10 screws that secure the base cover to the palm-rest assembly.
- 4 Gently snap the connector bezel into the base cover.







# Battery

 **WARNING:** Before working inside your computer, read the safety information that shipped with your computer. For additional safety best practices information, see the Regulatory Compliance Homepage at [www.dell.com/regulatory\\_compliance](http://www.dell.com/regulatory_compliance).

 **CAUTION:** Only a certified service technician should perform repairs on your computer. Damage due to servicing that is not authorized by Dell™ is not covered by your warranty.

 **CAUTION:** To avoid electrostatic discharge, ground yourself by using a wrist grounding strap or by periodically touching an unpainted metal surface (such as a connector on your computer).

 **CAUTION:** To avoid damage to the computer, use only the battery designed for this particular Dell computer. Do not use batteries designed for other Dell computers.

## Removing the Battery

- 1 Follow the instructions in "Before You Begin" on page 9.
- 2 Remove the base cover (see "Removing the Base Cover" on page 13).
- 3 Disconnect the battery cable from the system-board connector.
- 4 Remove the six screws that secure the battery to the palm-rest assembly.
- 5 Lift the battery out of the computer.

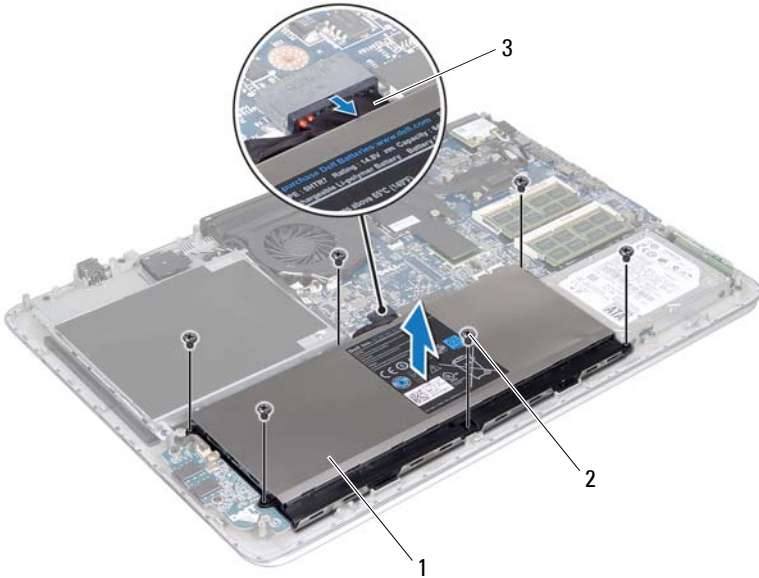

- 1 battery
- 2 screws (6)
- 3 battery cable

## Replacing the Battery

**CAUTION:** To avoid damage to the computer, use only the battery designed for this particular Dell computer.

- 1 Follow the instructions in "Before You Begin" on page 9.
- 2 Place the battery on the palm-rest assembly.
- 3 Replace the six screws that secure the battery to the palm-rest assembly.
- 4 Connect the battery cable to the system-board connector.
- 5 Replace the base cover (see "Replacing the Base Cover" on page 15).

# Memory Module(s)

 **WARNING:** Before working inside your computer, read the safety information that shipped with your computer. For additional safety best practices information, see the Regulatory Compliance Homepage at [www.dell.com/regulatory\\_compliance](http://www.dell.com/regulatory_compliance).

 **CAUTION:** Only a certified service technician should perform repairs on your computer. Damage due to servicing that is not authorized by Dell™ is not covered by your warranty.

 **CAUTION:** To avoid electrostatic discharge, ground yourself by using a wrist grounding strap or by periodically touching an unpainted metal surface (such as a connector on your computer).

 **CAUTION:** To help prevent damage to the system board, remove the main battery (see "Removing the Battery" on page 17) before working inside the computer.

You can increase your computer memory by installing memory modules on the system board. See "Specifications" in the *Setup Guide* available on your computer or at [support.dell.com/manuals](http://support.dell.com/manuals) for information on the type of memory supported by your computer.

 **NOTE:** Memory modules purchased from Dell are covered under your computer warranty.

Your computer has two user-accessible SODIMM connectors, labeled DIMM A and DIMM B.

## Removing the Memory Module(s)

- 1 Follow the instructions in "Before You Begin" on page 9.
- 2 Remove the base cover (see "Removing the Base Cover" on page 13).
- 3 Remove the battery (see "Removing the Battery" on page 17).

 **CAUTION:** To help prevent damage to the memory-module connector, do not use tools to spread the memory module securing clips.

- 4 Use your fingertips to carefully spread apart the securing clips on each end of the memory-module connector until the memory module pops up.

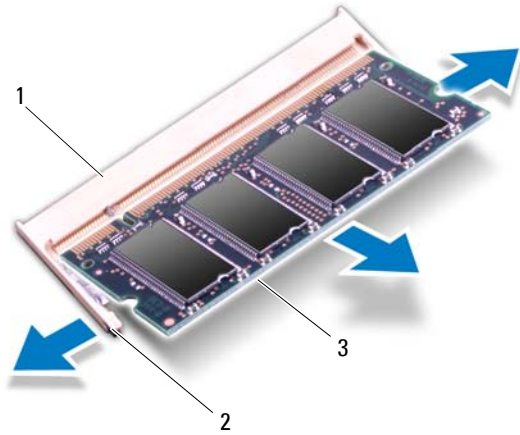

- 1 memory-module connector
- 2 securing clips (2)
- 3 memory module

5 Remove the memory module from the memory-module connector.

## Replacing the Memory Module(s)

**CAUTION:** If you need to install memory modules in two connectors, install a memory module in the connector labeled "DIMM A" before you install a memory module in the connector labeled "DIMM B".

- 1 Follow the instructions in "Before You Begin" on page 9.
- 2 Align the notch in the memory module with the tab in the memory-module connector.

- 3 Slide the memory module firmly into the memory-module connector at a 45-degree angle, and press the memory module down until it clicks into place. If you do not hear the click, remove the memory module and reinstall it.

 **NOTE:** If the memory module is not installed properly, the computer may not boot.

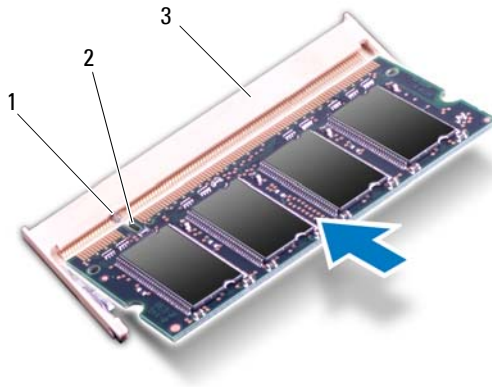

- 1 tab
- 2 notch
- 3 memory-module connector

- 4 Replace the battery (see "Replacing the Battery" on page 18).
- 5 Replace the base cover (see "Replacing the Base Cover" on page 15).
- 6 Connect the AC adapter to your computer and an electrical outlet.

 **CAUTION:** Before turning on the computer, replace all screws and ensure that no stray screws remain inside the computer. Failure to do so may result in damage to the computer.

- 7 Turn on the computer.

As the computer boots, it detects the additional memory and automatically updates the system configuration information.

To confirm the amount of memory installed in the computer:

Click Start  → Control Panel → System and Security → System.

# Wireless Mini-Card

 **WARNING:** Before working inside your computer, read the safety information that shipped with your computer. For additional safety best practices information, see the Regulatory Compliance Homepage at [www.dell.com/regulatory\\_compliance](http://www.dell.com/regulatory_compliance).

 **CAUTION:** Only a certified service technician should perform repairs on your computer. Damage due to servicing that is not authorized by Dell™ is not covered by your warranty.

 **CAUTION:** To avoid electrostatic discharge, ground yourself by using a wrist grounding strap or by periodically touching an unpainted metal surface (such as a connector on your computer).

 **CAUTION:** To help prevent damage to the system board, remove the main battery (see "Removing the Battery" on page 17) before working inside the computer.

 **NOTE:** Dell does not guarantee compatibility or provide support for Mini-Cards from sources other than Dell.

If you ordered a wireless Mini-Card with your computer, the card is already installed.

Your computer has one half Mini-Card slot which supports a Wireless Local Area Network (WLAN) and Bluetooth combo card.

 **NOTE:** Depending on the configuration of the computer when it was sold, the Mini-Card slot may or may not have a Mini-Card installed.

## Removing the Mini-Card

- 1 Follow the instructions in "Before You Begin" on page 9.
- 2 Remove the base cover (see "Removing the Base Cover" on page 13).
- 3 Remove the battery (see "Removing the Battery" on page 17).
- 4 Disconnect the antenna cables from the Mini-Card.
- 5 Remove the screw that secures the Mini-Card to the system board.

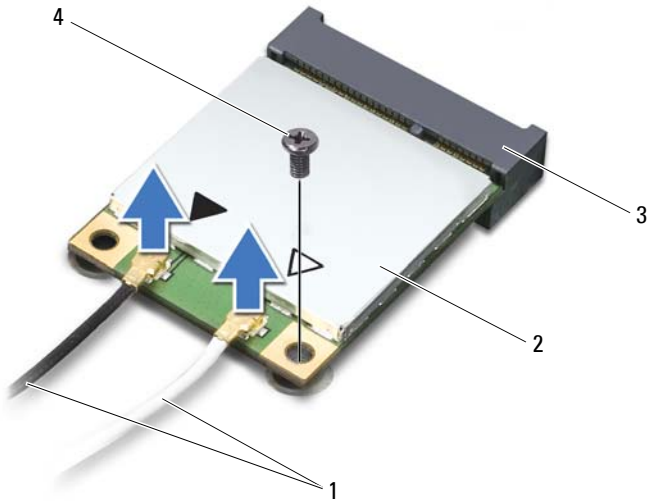

- |   |                        |   |           |
|---|------------------------|---|-----------|
| 1 | antenna cables (2)     | 2 | Mini-Card |
| 3 | system-board connector | 4 | screw     |

**6** Lift the Mini-Card out of the system-board connector.



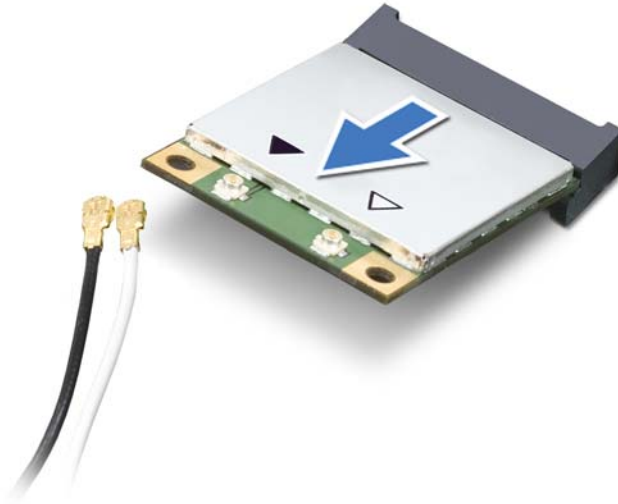

△ **CAUTION:** When the Mini-Card is not in the computer, store it in protective antistatic packaging. For more information, see "Protecting Against Electrostatic Discharge" in the safety information that shipped with your computer.

## Replacing the Mini-Card

- 1 Follow the instructions in "Before You Begin" on page 9.
- 2 Remove the new Mini-Card from its packaging.

△ **CAUTION:** Use firm and even pressure to slide the card into place. If you use excessive force, you may damage the connector.

△ **CAUTION:** The connectors are keyed to ensure correct insertion. If you feel resistance, check the connectors on the card and on the system board, and realign the card.

△ **CAUTION:** To avoid damage to the Mini-Card, never place cables under the card.

- 3 Insert the Mini-Card connector at a 45-degree angle into the system-board connector.
- 4 Press the other end of the Mini-Card down into the slot on the system board and replace the screw that secures the Mini-Card to the system board.
- 5 Connect the appropriate antenna cables to the Mini-Card you are installing.

Connectors on the Mini-Card	Antenna Cable Color Scheme
<b>WLAN + Bluetooth (2 antenna cables)</b>	
Main WLAN + Bluetooth (white triangle)	white
Auxiliary WLAN + Bluetooth (black triangle)	black

- 6 Replace the battery (see "Replacing the Battery" on page 18).
- 7 Replace the base cover (see "Replacing the Base Cover" on page 15).

 **CAUTION: Before turning on the computer, replace all screws and ensure that no stray screws remain inside the computer. Failure to do so may result in damage to the computer.**

- 8 Install the drivers and utilities for your Mini-Card, as required.

 **NOTE:** If you are installing a Mini-Card from a source other than Dell, you must install the appropriate drivers and utilities.

# Hard Drive

 **WARNING:** Before working inside your computer, read the safety information that shipped with your computer. For additional safety best practices information, see the Regulatory Compliance Homepage at [www.dell.com/regulatory\\_compliance](http://www.dell.com/regulatory_compliance).

 **WARNING:** If you remove the hard drive from the computer when the drive is hot, *do not touch* the metal housing of the hard drive.

 **CAUTION:** Only a certified service technician should perform repairs on your computer. Damage due to servicing that is not authorized by Dell™ is not covered by your warranty.

 **CAUTION:** To avoid electrostatic discharge, ground yourself by using a wrist grounding strap or by periodically touching an unpainted metal surface (such as a connector on your computer).

 **CAUTION:** To help prevent damage to the system board, remove the main battery (see "Removing the Battery" on page 17) before working inside the computer.

 **CAUTION:** To prevent data loss, turn off your computer (see "Turning Off Your Computer" on page 9) before removing the hard drive. Do not remove the hard drive while the computer is On or in Sleep state.

 **CAUTION:** Hard drives are extremely fragile. Exercise care when handling the hard drive.

 **NOTE:** Dell does not guarantee compatibility or provide support for hard drives from sources other than Dell.

 **NOTE:** If you are installing a hard drive from a source other than Dell, you need to install an operating system, drivers, and utilities on the new hard drive.

## Removing the Hard Drive

- 1 Follow the instructions in "Before You Begin" on page 9.
- 2 Remove the base cover (see "Removing the Base Cover" on page 13).
- 3 Remove the battery (see "Removing the Battery" on page 17).
- 4 Remove the four screws that secure the hard-drive assembly to the palm-rest assembly.

- 5 Disconnect the hard-drive cable from the hard drive.
- 6 Lift the hard-drive assembly out of the palm-rest assembly.

**CAUTION:** When the hard drive is not in the computer, store it in protective antistatic packaging (see "Protecting Against Electrostatic Discharge" in the safety instructions that shipped with your computer).

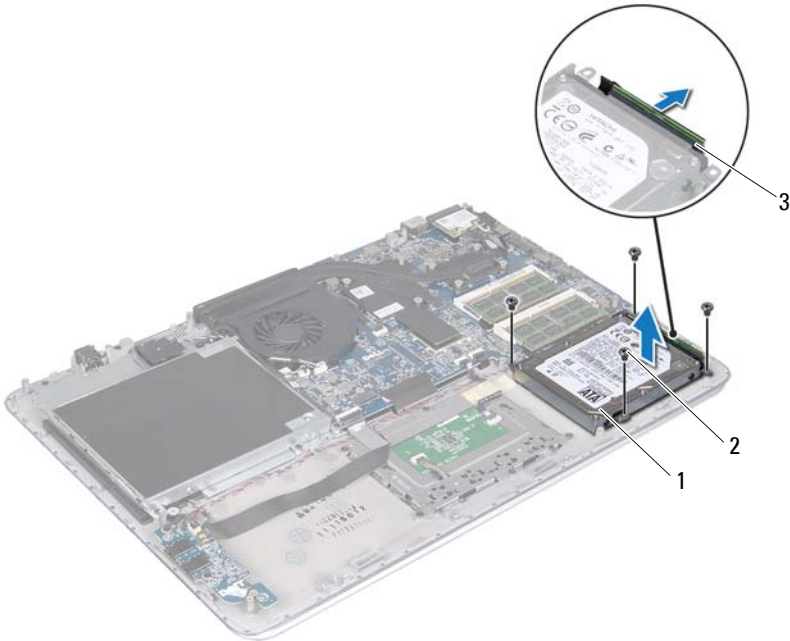

- |   |                            |   |            |
|---|----------------------------|---|------------|
| 1 | hard-drive assembly        | 2 | screws (4) |
| 3 | hard-drive cable connector |   |            |

- 7 Remove the four screws that secure the hard-drive bracket to the hard drive.

- 8 Lift the hard-drive bracket off the hard drive.

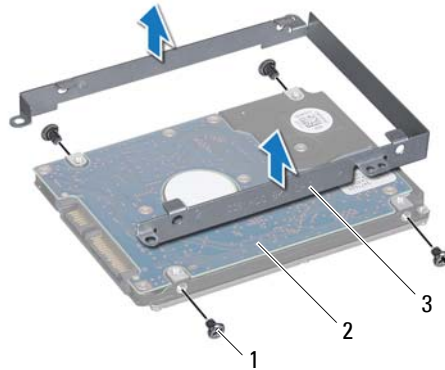

- 1 screws (4)
- 2 hard drive
- 3 hard-drive bracket





## Replacing the Hard Drive

- 1 Follow the instructions in "Before You Begin" on page 9.
- 2 Remove the new hard drive from its packaging.  
Save the original packaging for storing or shipping the hard drive.
- 3 Place the hard-drive bracket on the hard drive.
- 4 Replace the four screws that secure the hard-drive bracket to the hard drive.
- 5 Connect the hard-drive cable to the hard drive.
- 6 Place the hard-drive assembly on the palm-rest assembly.
- 7 Replace the four screws that secure the hard-drive assembly to the palm-rest assembly.
- 8 Replace the battery (see "Replacing the Battery" on page 18).
- 9 Replace the base cover (see "Replacing the Base Cover" on page 15).



**CAUTION:** Before turning on the computer, replace all screws and ensure that no stray screws remain inside the computer. Failure to do so may result in damage to the computer.

## Coin-Cell Battery

-  **WARNING:** Before working inside your computer, read the safety information that shipped with your computer. For additional safety best practices information, see the Regulatory Compliance Homepage at [www.dell.com/regulatory\\_compliance](http://www.dell.com/regulatory_compliance).
-  **CAUTION:** Only a certified service technician should perform repairs on your computer. Damage due to servicing that is not authorized by Dell™ is not covered by your warranty.
-  **CAUTION:** To avoid electrostatic discharge, ground yourself by using a wrist grounding strap or by periodically touching an unpainted metal surface (such as a connector on your computer).
-  **CAUTION:** To help prevent damage to the system board, remove the main battery (see "Removing the Battery" on page 17) before working inside the computer.

### Removing the Coin-Cell Battery

- 1 Follow the instructions in "Before You Begin" on page 9.
- 2 Remove the base cover (see "Removing the Base Cover" on page 13).
- 3 Remove the battery (see "Removing the Battery" on page 17).
- 4 Disconnect the coin-cell battery cable from the system-board connector.
- 5 Make note of the coin-cell battery cable routing and remove the cable from the routing guides.
- 6 Slide and lift the coin-cell battery out of the computer.



1 coin-cell-battery cable connector 2 coin-cell battery

## Replacing the Coin-Cell Battery

- 1 Follow the instructions in "Before You Begin" on page 9.
- 2 Slide and place the coin-cell battery on the palm-rest assembly and route the coin-cell battery cable as noted earlier.
- 3 Connect the coin-cell battery cable to the system-board connector.
- 4 Replace the battery (see "Replacing the Battery" on page 18).
- 5 Replace the base cover (see "Replacing the Base Cover" on page 15).







**CAUTION:** Before turning on the computer, replace all screws and ensure that no stray screws remain inside the computer. Failure to do so may result in damage to the computer.



# Optical Drive

 **WARNING:** Before working inside your computer, read the safety information that shipped with your computer. For additional safety best practices information, see the Regulatory Compliance Homepage at [www.dell.com/regulatory\\_compliance](http://www.dell.com/regulatory_compliance).

 **CAUTION:** Only a certified service technician should perform repairs on your computer. Damage due to servicing that is not authorized by Dell™ is not covered by your warranty.

 **CAUTION:** To avoid electrostatic discharge, ground yourself by using a wrist grounding strap or by periodically touching an unpainted metal surface (such as a connector on your computer).

 **CAUTION:** To help prevent damage to the system board, remove the main battery (see "Removing the Battery" on page 17) before working inside the computer.

## Removing the Optical Drive

- 1 Follow the instructions in "Before You Begin" on page 9.
- 2 Remove the base cover (see "Removing the Base Cover" on page 13).
- 3 Remove the battery (see "Removing the Battery" on page 17).
- 4 Remove the coin-cell battery (see "Removing the Coin-Cell Battery" on page 31).
- 5 Remove the four screws that secure the optical drive to the palm-rest assembly.
- 6 Slide and lift the optical drive out of the palm-rest assembly.

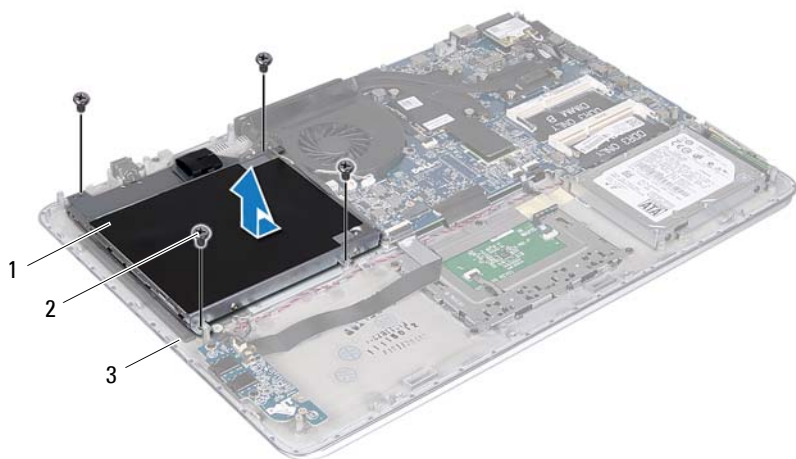

1 optical drive

2 screws (4)

3 base cover

**7** Remove the four screws (two on each side) that secure the optical-drive brackets to the optical drive.

**8** Remove the optical-drive brackets from the optical drive.

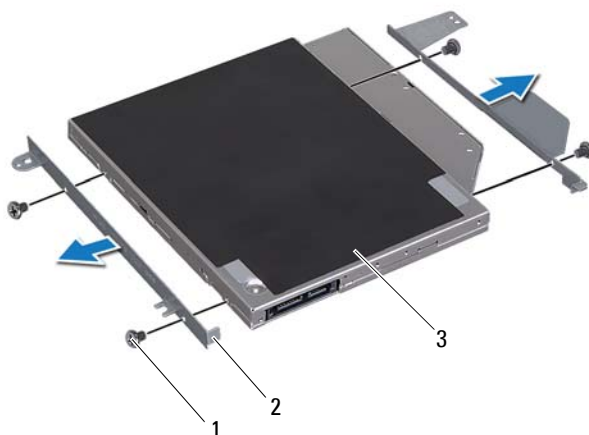

- 1 screws (4)
- 2 optical-drive brackets (2)
- 3 optical drive

## Replacing the Optical Drive





- 1 Follow the instructions in "Before You Begin" on page 9.
- 2 Place the optical-drive brackets in position.
- 3 Replace the four screws (two on each side) that secure the optical-drive brackets to the optical drive.
- 4 Place the optical drive on the palm-rest assembly.
- 5 Replace the four screws that secure the optical drive to the palm-rest assembly.
- 6 Replace the coin-cell battery (see "Replacing the Coin-Cell Battery" on page 32).
- 7 Replace the battery (see "Replacing the Battery" on page 18).

8 Replace the base cover (see "Replacing the Base Cover" on page 15).



**CAUTION: Before turning on the computer, replace all screws and ensure that no stray screws remain inside the computer. Failure to do so may result in damage to the computer.**

# AC-Adapter Connector

-  **WARNING:** Before working inside your computer, read the safety information that shipped with your computer. For additional safety best practices information, see the Regulatory Compliance Homepage at [www.dell.com/regulatory\\_compliance](http://www.dell.com/regulatory_compliance).
-  **CAUTION:** Only a certified service technician should perform repairs on your computer. Damage due to servicing that is not authorized by Dell™ is not covered by your warranty.
-  **CAUTION:** To avoid electrostatic discharge, ground yourself by using a wrist grounding strap or by periodically touching an unpainted metal surface (such as a connector on your computer).
-  **CAUTION:** To help prevent damage to the system board, remove the main battery (see "Removing the Battery" on page 17) before working inside the computer.

## Removing the AC-Adapter Connector

- 1 Follow the instructions in "Before You Begin" on page 9.
- 2 Remove the base cover (see "Removing the Base Cover" on page 13).
- 3 Remove the battery (see "Removing the Battery" on page 17).
- 4 Remove the coin-cell battery (see "Removing the Coin-Cell Battery" on page 31).
- 5 Remove the optical drive (see "Removing the Optical Drive" on page 35).
- 6 Make note of the AC-adapter connector cable routing and remove the cable from the routing guides.
- 7 Disconnect the AC-adapter connector cable from the system-board connector.
- 8 Remove the screw that secures the AC-adapter connector to the palm-rest assembly.
- 9 Lift the AC-adapter connector off the palm-rest assembly.

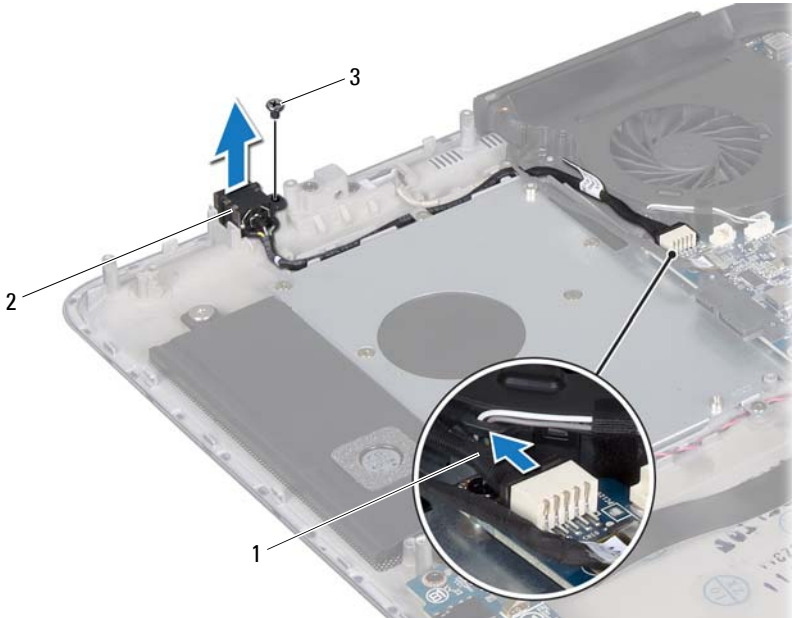

- 1 AC-adapter connector cable      2 AC-adapter connector  
3 screw

## Replacing the AC-Adapter Connector

- 1 Follow the instructions in "Before You Begin" on page 9.
- 2 Align the screw hole on the AC-adapter connector with the screw hole on the palm-rest assembly.
- 3 Replace the screw that secures the AC-adapter connector to the palm-rest assembly.
- 4 Route the AC-adapter connector cable through the routing guides.
- 5 Connect the AC-adapter connector cable to the system-board connector.
- 6 Replace the optical drive (see "Replacing the Optical Drive" on page 37).
- 7 Replace the coin-cell battery (see "Replacing the Coin-Cell Battery" on page 32).





- 8 Replace the battery (see "Replacing the Battery" on page 18).
- 9 Replace the base cover (see "Replacing the Base Cover" on page 15).

 **CAUTION: Before turning on the computer, replace all screws and ensure that no stray screws remain inside the computer. Failure to do so may result in damage to the computer.**



## Power-Button Board

 **WARNING:** Before working inside your computer, read the safety information that shipped with your computer. For additional safety best practices information, see the Regulatory Compliance Homepage at [www.dell.com/regulatory\\_compliance](http://www.dell.com/regulatory_compliance).

 **CAUTION:** Only a certified service technician should perform repairs on your computer. Damage due to servicing that is not authorized by Dell™ is not covered by your warranty.

 **CAUTION:** To avoid electrostatic discharge, ground yourself by using a wrist grounding strap or by periodically touching an unpainted metal surface (such as a connector on your computer).

 **CAUTION:** To help prevent damage to the system board, remove the main battery (see "Removing the Battery" on page 17) before working inside the computer.

## Removing the Power-Button Board

- 1 Follow the instructions in "Before You Begin" on page 9.
- 2 Remove the base cover (see "Removing the Base Cover" on page 13).
- 3 Remove the battery (see "Removing the Battery" on page 17).
- 4 Remove the fan (see "Removing the Fan" on page 55).
- 5 Remove the heat sink (see "Removing the Heat Sink" on page 57).
- 6 Lift the connector latch and disconnect the power-button-board cable from the connector on the system board.
- 7 Remove the two screws that secure the power-button board to the palm-rest assembly.
- 8 Lift the power-button board along with the cable away from the computer.

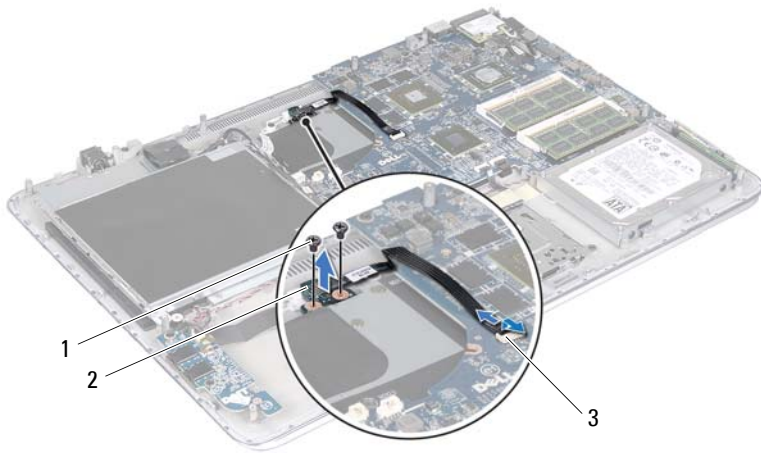

- 1 screws (2)
- 2 power-button board
- 3 power-button board cable connector

## Replacing the Power-Button Board





- 1 Follow the instructions in "Before You Begin" on page 9.
- 2 Use the alignment posts to place the power-button board on the palm-rest assembly.
- 3 Replace the two screws that secure the power-button board to the palm-rest assembly.
- 4 Slide the power-button board cable into the connector on the system board and press down on the connector latch to secure the cable.
- 5 Replace the heat sink (see "Replacing the Heat Sink" on page 58).
- 6 Replace the fan (see "Replacing the Fan" on page 56).
- 7 Replace the battery (see "Replacing the Battery" on page 18).
- 8 Replace the base cover (see "Replacing the Base Cover" on page 15).



**CAUTION:** Before turning on the computer, replace all screws and ensure that no stray screws remain inside the computer. Failure to do so may result in damage to the computer.



# Audio Board

-  **WARNING:** Before working inside your computer, read the safety information that shipped with your computer. For additional safety best practices information, see the Regulatory Compliance Homepage at [www.dell.com/regulatory\\_compliance](http://www.dell.com/regulatory_compliance).
-  **CAUTION:** Only a certified service technician should perform repairs on your computer. Damage due to servicing that is not authorized by Dell™ is not covered by your warranty.
-  **CAUTION:** To avoid electrostatic discharge, ground yourself by using a wrist grounding strap or by periodically touching an unpainted metal surface (such as a connector on your computer).
-  **CAUTION:** To help prevent damage to the system board, remove the main battery (see "Removing the Battery" on page 17) before working inside the computer.

## Removing the Audio Board

- 1 Follow the instructions in "Before You Begin" on page 9.
- 2 Remove the base cover (see "Removing the Base Cover" on page 13).
- 3 Remove the battery (see "Removing the Battery" on page 17).
- 4 Lift the connector latch and disconnect the audio-board cable from the connector on the system board.
- 5 Disconnect the speaker cable from the connector on the audio board.
- 6 Remove the two screws that secure the audio board to the palm-rest assembly.
- 7 Lift the audio board out of the computer.

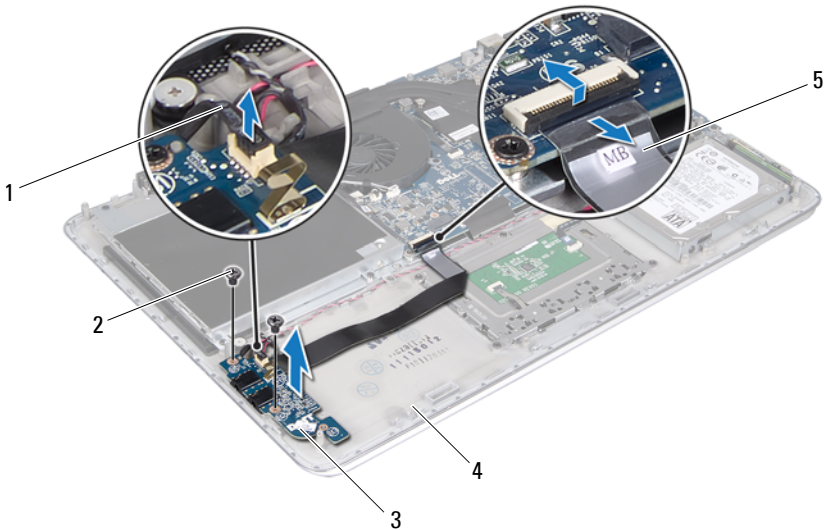

- |   |                   |   |                    |
|---|-------------------|---|--------------------|
| 1 | speaker cable     | 2 | screws (2)         |
| 3 | audio board       | 4 | palm-rest assembly |
| 5 | audio-board cable |   |                    |

## Replacing the Audio Board

- 1 Follow the instructions in "Before You Begin" on page 9.
- 2 Align the screw holes on the audio board with the screw holes on the palm-rest assembly.
- 3 Replace the two screws that secure the audio board to the palm-rest assembly.
- 4 Slide the audio-board cable into the connector on the system board and press the connector latch down to secure the cable.
- 5 Connect the speaker cable to the connector on the audio board.



- 6 Replace the battery (see "Replacing the Battery" on page 18).
- 7 Replace the base cover (see "Replacing the Base Cover" on page 15).

 **CAUTION: Before turning on the computer, replace all screws and ensure that no stray screws remain inside the computer. Failure to do so may result in damage to the computer.**



## Battery Status-Light Board

 **WARNING:** Before working inside your computer, read the safety information that shipped with your computer. For additional safety best practices information, see the Regulatory Compliance Homepage at [www.dell.com/regulatory\\_compliance](http://www.dell.com/regulatory_compliance).

 **CAUTION:** To avoid electrostatic discharge, ground yourself by using a wrist grounding strap or by periodically touching an unpainted metal surface (such as a connector on your computer).

 **CAUTION:** Only a certified service technician should perform repairs on your computer. Damage due to servicing that is not authorized by Dell is not covered by your warranty.

 **CAUTION:** To help prevent damage to the system board, remove the main battery (see "Removing the Battery" on page 17) before working inside the computer.

## Removing the Battery Status-Light Board

- 1 Follow the instructions in "Before You Begin" on page 9.
- 2 Remove the base cover (see "Removing the Base Cover" on page 13).
- 3 Remove the battery (see "Removing the Battery" on page 17).
- 4 Remove the hard drive (see "Removing the Hard Drive" on page 27).
- 5 Remove the screw that secures the battery status-light board to the palm-rest assembly.
- 6 Without pulling hard on the battery status-light board, carefully lift the battery status-light board.
- 7 Lift the connector latch and disconnect the battery status-light-board cable from the connector on the battery status-light board.

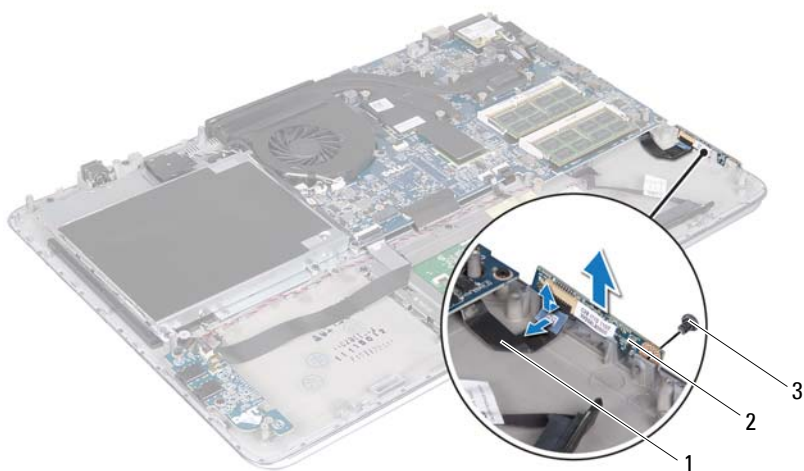

- 1 battery status-light board cable
- 2 battery status-light board
- 3 screw

## Replacing the Battery Status-Light Board





- 1 Follow the instructions in "Before You Begin" on page 9.
- 2 Slide the battery status-light-board cable into the connector on the battery status-light board and press down on the connector latch to secure the battery status-light-board cable to the connector on the battery status-light board.
- 3 Place the battery status-light board on the palm-rest assembly.

- 4 Replace the screw that secures the battery status-light board to the palm-rest assembly.
- 5 Replace the hard drive (see "Replacing the Hard Drive" on page 29).
- 6 Replace the battery (see "Replacing the Battery" on page 18).
- 7 Replace the base cover (see "Replacing the Base Cover" on page 15).

 **CAUTION: Before turning on the computer, replace all screws and ensure that no stray screws remain inside the computer. Failure to do so may result in damage to the computer.**



## Fan

-  **WARNING:** Before working inside your computer, read the safety information that shipped with your computer. For additional safety best practices information, see the Regulatory Compliance Homepage at [www.dell.com/regulatory\\_compliance](http://www.dell.com/regulatory_compliance).
-  **WARNING:** If you remove the fan from the computer when the heat sink is hot, *do not touch* the metal housing of the heat sink.
-  **CAUTION:** Only a certified service technician should perform repairs on your computer. Damage due to servicing that is not authorized by Dell™ is not covered by your warranty.
-  **CAUTION:** To avoid electrostatic discharge, ground yourself by using a wrist grounding strap or by periodically touching an unpainted metal surface (such as a connector on your computer).
-  **CAUTION:** To help prevent damage to the system board, remove the main battery (see "Removing the Battery" on page 17) before working inside the computer.

## Removing the Fan

- 1 Follow the instructions in "Before You Begin" on page 9.
- 2 Remove the base cover (see "Removing the Base Cover" on page 13).
- 3 Remove the battery (see "Removing the Battery" on page 17).
- 4 Disconnect the fan cable from the system-board connector.
- 5 Remove the two screws that secure the fan to the palm-rest assembly.
- 6 Lift the fan away from the palm-rest assembly.

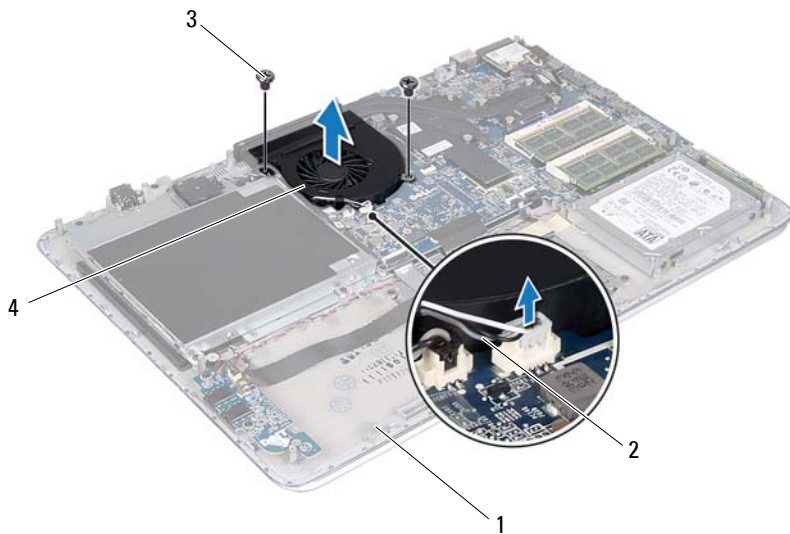

- |   |                    |   |           |
|---|--------------------|---|-----------|
| 1 | palm-rest assembly | 2 | fan cable |
| 3 | screws (2)         | 4 | fan       |

## Replacing the Fan

- 1 Follow the instructions in "Before You Begin" on page 9.
- 2 Align the screw holes on the fan with the screw holes on the palm-rest assembly.
- 3 Replace the two screws that secure the fan to the palm-rest assembly.
- 4 Connect the fan cable to the system-board connector.
- 5 Replace the battery (see "Replacing the Battery" on page 18).
- 6 Replace the base cover (see "Replacing the Base Cover" on page 15).

**CAUTION:** Before turning on the computer, replace all screws and ensure that no stray screws remain inside the computer. Failure to do so may result in damage to the computer.



## Heat Sink

 **WARNING:** Before working inside your computer, read the safety information that shipped with your computer. For additional safety best practices information, see the Regulatory Compliance Homepage at [www.dell.com/regulatory\\_compliance](http://www.dell.com/regulatory_compliance).

 **WARNING:** If you remove the heat sink from the computer when the heat sink is hot, *do not touch* the metal housing of the heat sink.

 **CAUTION:** Only a certified service technician should perform repairs on your computer. Damage due to servicing that is not authorized by Dell™ is not covered by your warranty.

 **CAUTION:** To avoid electrostatic discharge, ground yourself by using a wrist grounding strap or by periodically touching an unpainted metal surface (such as a connector on your computer).

 **CAUTION:** To help prevent damage to the system board, remove the main battery (see "Removing the Battery" on page 17) before working inside the computer.

## Removing the Heat Sink

- 1 Follow the instructions in "Before You Begin" on page 9.
- 2 Remove the base cover (see "Removing the Base Cover" on page 13).
- 3 Remove the battery (see "Removing the Battery" on page 17).
- 4 Remove the fan (see "Removing the Fan" on page 55).
- 5 In sequential order (indicated on the heat sink), loosen the seven captive screws that secure the heat sink to the system board.
- 6 Lift the heat sink away from the system board.

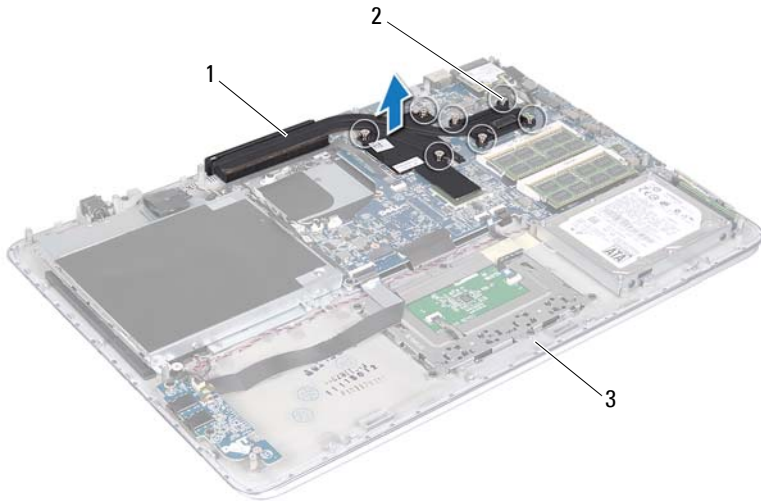

1 heat sink

2 captive screws (7)

3 palm-rest assembly

## Replacing the Heat Sink



**NOTE:** The original thermal grease can be reused if the original processor and heat sink are reinstalled together. If either the processor or the heat sink is replaced, use the thermal pad provided in the kit to ensure that thermal conductivity is achieved.

- 1 Follow the instructions in "Before You Begin" on page 9.
- 2 Clean the thermal grease from the bottom of the heat sink and reapply it.
- 3 Align the seven captive screws on the heat sink with the screw holes on the system board and tighten the screws in sequential order (indicated on the heat sink).
- 4 Replace the fan (see "Replacing the Fan" on page 56).
- 5 Replace the battery (see "Replacing the Battery" on page 18).
- 6 Replace the base cover (see "Replacing the Base Cover" on page 15).





**CAUTION:** Before turning on the computer, replace all screws and ensure that no stray screws remain inside the computer. Failure to do so may result in damage to the computer.





# System Board

 **WARNING:** Before working inside your computer, read the safety information that shipped with your computer. For additional safety best practices information, see the Regulatory Compliance Homepage at [www.dell.com/regulatory\\_compliance](http://www.dell.com/regulatory_compliance).

 **CAUTION:** Only a certified service technician should perform repairs on your computer. Damage due to servicing that is not authorized by Dell™ is not covered by your warranty.

 **CAUTION:** To avoid electrostatic discharge, ground yourself by using a wrist grounding strap or by periodically touching an unpainted metal surface (such as a connector on your computer).

 **CAUTION:** To help prevent damage to the system board, remove the main battery (see "Removing the Battery" on page 17) before working inside the computer.

 **CAUTION:** Handle components and cards by their edges, and avoid touching pins and contacts.

## Removing the System Board

- 1 Follow the instructions in "Before You Begin" on page 9.
- 2 Remove any installed card or blank from the Media Card Reader.
- 3 Remove the base cover (see "Removing the Base Cover" on page 13).
- 4 Remove the battery (see "Removing the Battery" on page 17).
- 5 Remove the memory module(s) (see "Removing the Memory Module(s)" on page 19).
- 6 Remove the Mini-Card (see "Removing the Mini-Card" on page 23).
- 7 Remove the hard drive (see "Removing the Hard Drive" on page 27).
- 8 Remove the coin-cell battery (see "Removing the Coin-Cell Battery" on page 31).
- 9 Remove the optical drive (see "Removing the Optical Drive" on page 35).
- 10 Remove the fan (see "Removing the Fan" on page 55).
- 11 Remove the heat sink (see "Removing the Heat Sink" on page 57).

**12** Disconnect the audio-board cable, keyboard cable, touch-pad cable, keyboard back-light cable, display cable, power-button board cable, AC-adapter connector cable, and camera cable from the connectors on the system board.

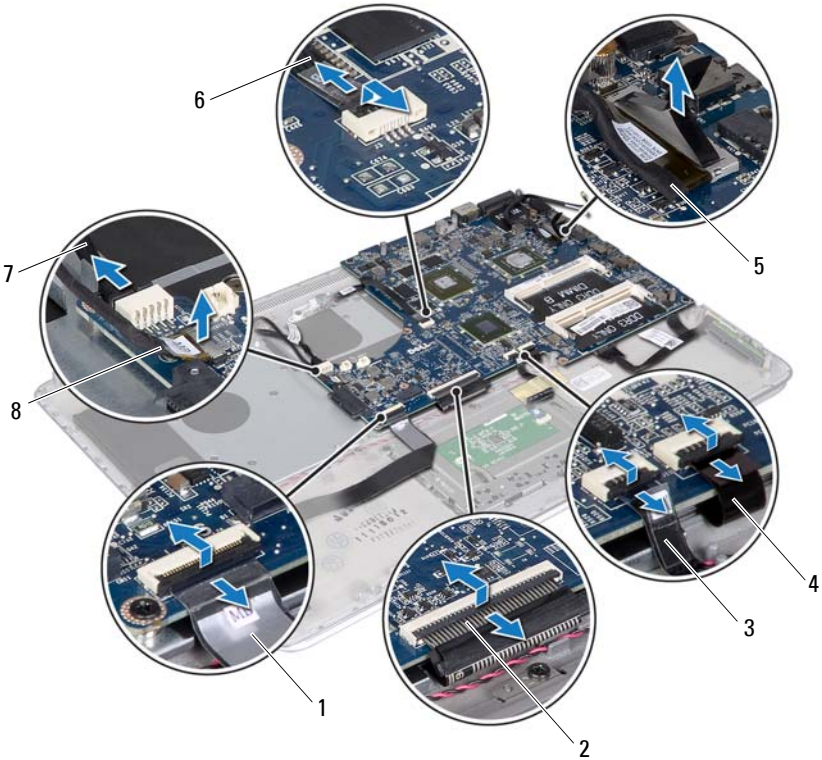

- |   |                            |   |                           |
|---|----------------------------|---|---------------------------|
| 1 | audio-board cable          | 2 | keyboard cable            |
| 3 | touch-pad cable            | 4 | keyboard back-light cable |
| 5 | display cable              | 6 | power-button board cable  |
| 7 | ac-adapter connector cable | 8 | camera cable              |

- 13** Remove the six screws that secure the system board to the palm-rest assembly.
- 14** Without pulling hard on the system board, carefully lift the system board and turn it over.

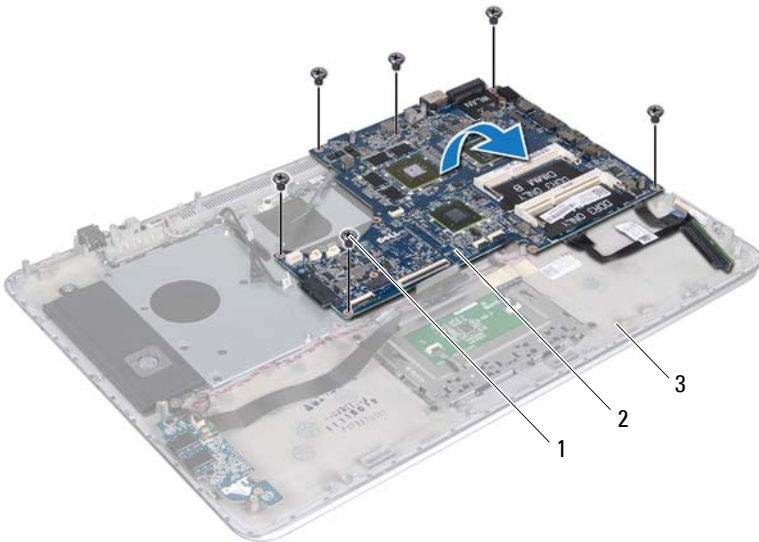

- |   |                    |   |              |
|---|--------------------|---|--------------|
| 1 | screws (6)         | 2 | system board |
| 3 | palm-rest assembly |   |              |

- 15** Disconnect the hard drive cable and the battery status-light-board cable from the system-board connectors.

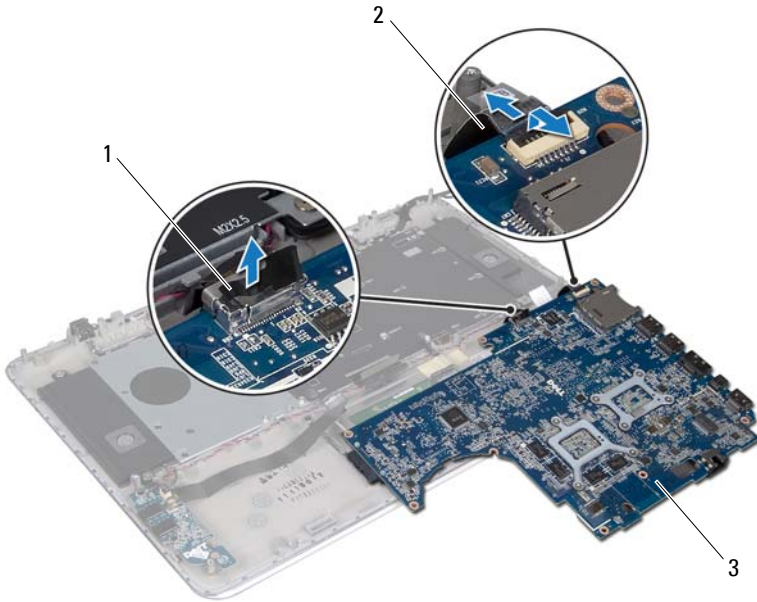

- 1 hard drive cable
- 3 system board

- 2 battery status-light-board cable

**16** Lift the system board off the palm-rest assembly.

## Replacing the System Board

- 1 Follow the instructions in "Before You Begin" on page 9.
- 2 Connect the hard drive cable and the battery status-light-board cable to the system-board connectors.
- 3 Place the system board on the palm-rest assembly.
- 4 Replace the six screws that secure the system board to the palm-rest assembly.



- 5 Connect the audio-board cable, keyboard cable, touch-pad cable, keyboard back-light cable, display cable, power-button board cable, AC-adapter connector cable, and camera cable to the connectors on the system board.
- 6 Replace the heat sink (see "Replacing the Heat Sink" on page 58).
- 7 Replace the fan (see "Replacing the Fan" on page 56).
- 8 Replace the optical drive (see "Replacing the Optical Drive" on page 37).
- 9 Replace the coin-cell battery (see "Replacing the Coin-Cell Battery" on page 32).
- 10 Replace the hard drive (see "Replacing the Hard Drive" on page 29).
- 11 Replace the Mini-Card (see "Replacing the Mini-Card" on page 25).
- 12 Replace the memory module(s) (see "Replacing the Memory Module(s)" on page 20).
- 13 Replace the battery (see "Replacing the Battery" on page 18).
- 14 Replace the base cover (see "Replacing the Base Cover" on page 15).
- 15 Replace any blank or card you removed from the Media Card Reader.



**CAUTION:** Before turning on the computer, replace all screws and ensure that no stray screws remain inside the computer. Failure to do so may result in damage to the computer.

- 16 Turn on the computer.



**NOTE:** After you have replaced the system board, enter the computer Service Tag in the BIOS of the replacement system board.





- 17 Enter the Service Tag (see "Entering the Service Tag in the BIOS" on page 65).

## Entering the Service Tag in the BIOS

- 1 Ensure that the AC adapter is plugged in and that the main battery is installed properly.
- 2 Turn on the computer.
- 3 Press <F2> during POST to enter the System Setup program.
- 4 Navigate to the Security tab and enter the Service Tag in the Set Service Tag field.



# Keyboard

-  **WARNING:** Before working inside your computer, read the safety information that shipped with your computer. For additional safety best practices information, see the Regulatory Compliance Homepage at [www.dell.com/regulatory\\_compliance](http://www.dell.com/regulatory_compliance).
-  **CAUTION:** Only a certified service technician should perform repairs on your computer. Damage due to servicing that is not authorized by Dell™ is not covered by your warranty.
-  **CAUTION:** To avoid electrostatic discharge, ground yourself by using a wrist grounding strap or by periodically touching an unpainted metal surface (such as a connector on your computer).
-  **CAUTION:** To help prevent damage to the system board, remove the main battery (see "Removing the Battery" on page 17) before working inside the computer.

## Removing the Keyboard Bracket

- 1 Follow the instructions in "Before You Begin" on page 9.
- 2 Remove the base cover (see "Removing the Base Cover" on page 13).
- 3 Remove the battery (see "Removing the Battery" on page 17).
- 4 Follow the instructions from step 5 to step 16 in Removing the System Board.
- 5 Remove the 16 screws that secure the keyboard bracket to the palm-rest assembly.

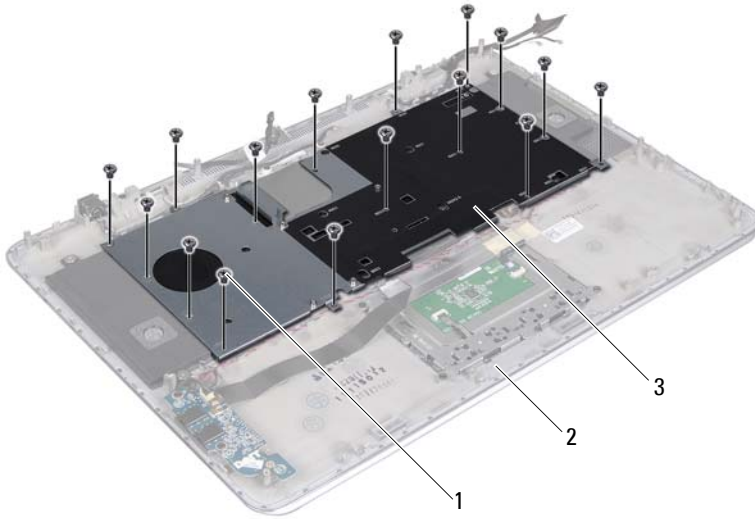

1 screws (16)

2 palm-rest assembly

3 keyboard bracket

**6** Lift the keyboard bracket off the palm-rest assembly.

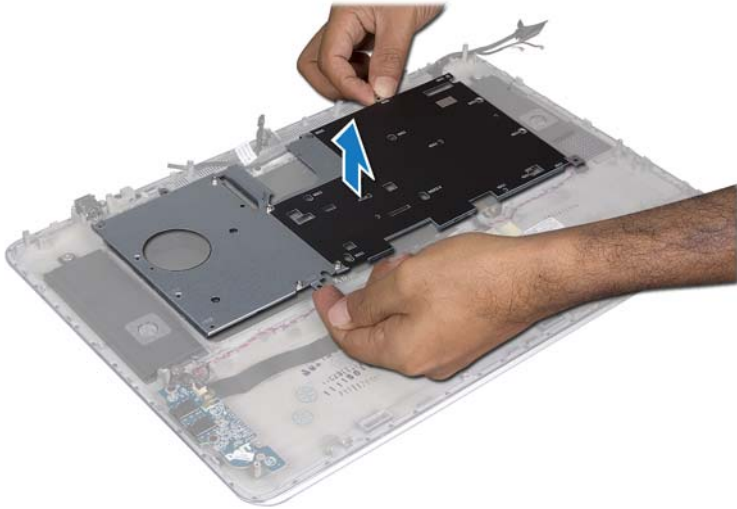

## Replacing the Keyboard Bracket

- 1 Follow the instructions in "Before You Begin" on page 9.
- 2 Place the keyboard bracket on the palm-rest assembly.
- 3 Replace the 16 screws that secure the keyboard bracket to the palm-rest assembly.
- 4 Follow the instructions from step 2 to step 12 in Replacing the System Board.
- 5 Replace the battery (see "Replacing the Battery" on page 18).
- 6 Replace the base cover (see "Replacing the Base Cover" on page 15).

## Removing the Keyboard

- 1 Follow the instructions in "Before You Begin" on page 9.

- 2 Remove the keyboard bracket (see "Removing the Keyboard Bracket" on page 67).

**⚠ CAUTION: The keycaps on the keyboard are fragile, easily dislodged, and time-consuming to replace. Be careful when removing and handling the keyboard.**

- 3 Remove the eight screws that secure the keyboard to the palm-rest assembly.
- 4 Lift the keyboard off the palm-rest assembly.

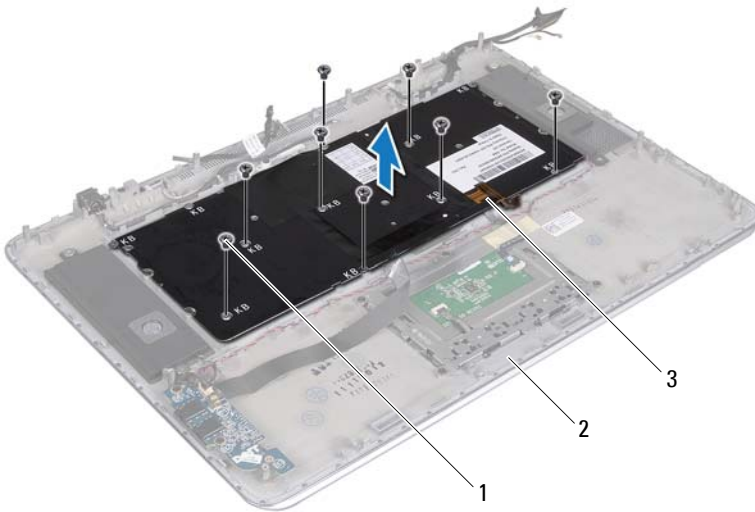

- 1 screws (8)
- 3 keyboard

- 2 palm-rest assembly

## Replacing the Keyboard

- 1 Follow the instructions in "Before You Begin" on page 9.
- 2 Place the keyboard on the palm-rest assembly.

- 3 Replace the eight screws that secure the keyboard to the palm-rest assembly.
- 4 Replace the keyboard bracket (see "Replacing the Keyboard Bracket" on page 69).







**CAUTION: Before turning on the computer, replace all screws and ensure that no stray screws remain inside the computer. Failure to do so may result in damage to the computer.**





# Speakers

-  **WARNING:** Before working inside your computer, read the safety information that shipped with your computer. For additional safety best practices information, see the Regulatory Compliance Homepage at [www.dell.com/regulatory\\_compliance](http://www.dell.com/regulatory_compliance).
-  **CAUTION:** Only a certified service technician should perform repairs on your computer. Damage due to servicing that is not authorized by Dell™ is not covered by your warranty.
-  **CAUTION:** To avoid electrostatic discharge, ground yourself by using a wrist grounding strap or by periodically touching an unpainted metal surface (such as a connector on your computer).
-  **CAUTION:** To help prevent damage to the system board, remove the main battery (see "Removing the Battery" on page 17) before working inside the computer.

## Removing the Speakers

- 1 Follow the instructions in "Before You Begin" on page 9.
- 2 Remove the base cover (see "Removing the Base Cover" on page 13).
- 3 Remove the battery (see "Removing the Battery" on page 17).
- 4 Follow the instructions from step 5 to step 16 in Removing the System Board.
- 5 Remove the keyboard bracket (see "Removing the Keyboard Bracket" on page 67).
- 6 Disconnect the speaker cable from the connector on the audio board.
- 7 Remove the four screws (two on each side) that secure the speakers to the palm-rest assembly.
- 8 Make a note of the speakers cable routing and lift the speakers along with the cable off the palm-rest assembly.

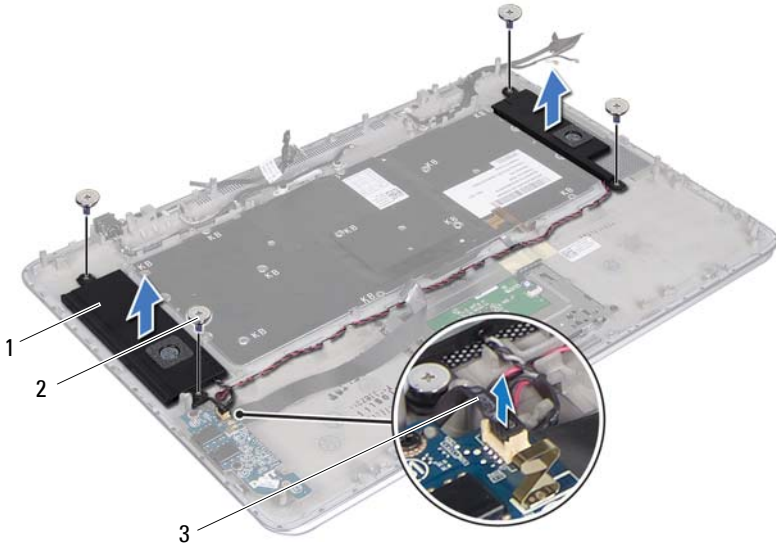

- 1 speakers (2)
- 3 speaker cable

- 2 screws (4)

## Replacing the Speakers





- 1 Follow the instructions in "Before You Begin" on page 9.
- 2 Place the speakers on the palm-rest assembly and route the speakers cable through the routing guides.
- 3 Replace the four screws (two on each side) that secure the speakers to the palm-rest assembly.
- 4 Connect the speaker cable to the connector on the audio board.
- 5 Replace the four screws (two on each speaker) that secure the speakers to the base cover.

- 6 Replace the keyboard bracket (see "Replacing the Keyboard Bracket" on page 69).
- 7 Follow the instructions from step 2 to step 12 in Replacing the System Board.
- 8 Replace the battery (see "Replacing the Battery" on page 18).
- 9 Replace the base cover (see "Replacing the Base Cover" on page 15).

 **CAUTION: Before turning on the computer, replace all screws and ensure that no stray screws remain inside the computer. Failure to do so may result in damage to the computer.**



## Palm-Rest Assembly

-  **WARNING:** Before working inside your computer, read the safety information that shipped with your computer. For additional safety best practices information, see the Regulatory Compliance Homepage at [www.dell.com/regulatory\\_compliance](http://www.dell.com/regulatory_compliance).
-  **CAUTION:** Only a certified service technician should perform repairs on your computer. Damage due to servicing that is not authorized by Dell™ is not covered by your warranty.
-  **CAUTION:** To avoid electrostatic discharge, ground yourself by using a wrist grounding strap or by periodically touching an unpainted metal surface (such as a connector on your computer).
-  **CAUTION:** To help prevent damage to the system board, remove the main battery (see "Removing the Battery" on page 17) before working inside the computer.

## Removing the Palm-Rest Assembly

- 1 Follow the instructions in "Before You Begin" on page 9.
- 2 Remove the base cover (see "Removing the Base Cover" on page 13).
- 3 Remove the battery (see "Removing the Battery" on page 17).
- 4 Follow the instructions from step 5 to step 16 in Removing the System Board.
- 5 Remove the keyboard (see "Removing the Keyboard" on page 69).
- 6 Remove the speakers (see "Removing the Speakers" on page 73).
- 7 Remove the power-button board (see "Removing the Power-Button Board" on page 43).
- 8 Remove the ac-adaptor connector (see "Removing the AC-Adapter Connector" on page 39).
- 9 Remove the audio board (see "Removing the Audio Board" on page 47).
- 10 Remove the battery status-light board (see "Removing the Battery Status-Light Board" on page 51).

- 11 Remove the six screws that secure the palm-rest assembly to the display assembly.
- 12 Note the routing of camera cable, display cable, and Mini-Card antenna cables and remove the cables from the routing guides.
- 13 Lift the palm-rest assembly off the display assembly.

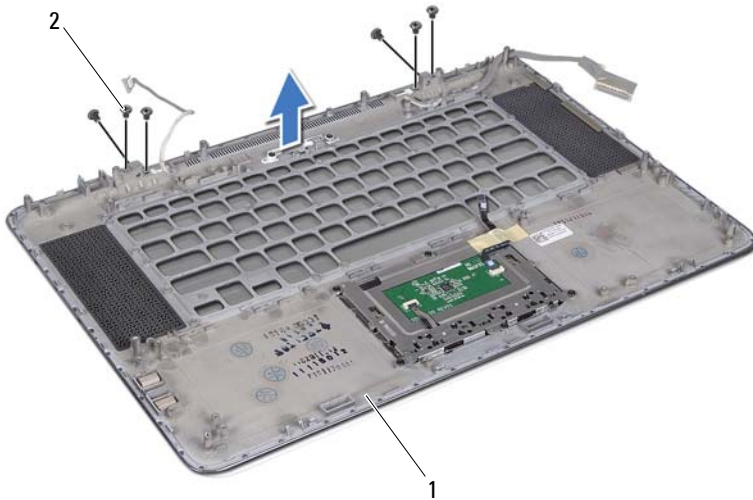

1 palm-rest assembly

2 screws (6)



**CAUTION:** Carefully separate the palm-rest assembly from the display assembly to avoid damage to the display assembly.

## Replacing the Palm-Rest Assembly

- 1 Follow the instructions in "Before You Begin" on page 9.
- 2 Place the palm-rest assembly on the display assembly and route the display cable, camera cable, and Mini-Card antenna cables through the routing guides.

- 3 Replace the six screws that secure the palm-rest assembly to the display assembly.
- 4 Replace the battery status-light board (see "Replacing the Battery Status-Light Board" on page 52).
- 5 Replace the audio board (see "Replacing the Audio Board" on page 48).
- 6 Replace the ac-adaptor connector (see "Replacing the AC-Adapter Connector" on page 40).
- 7 Replace the power-button board (see "Replacing the Power-Button Board" on page 44).
- 8 Replace the speakers (see "Replacing the Speakers" on page 74).
- 9 Replace the keyboard (see "Replacing the Keyboard" on page 70).
- 10 Follow the instructions from step 2 to step 12 in Replacing the System Board.
- 11 Replace the battery (see "Replacing the Battery" on page 18).
- 12 Replace the base cover (see "Replacing the Base Cover" on page 15).





**CAUTION: Before turning on the computer, replace all screws and ensure that no stray screws remain inside the computer. Failure to do so may result in damage to the computer.**





# Display

 **WARNING:** Before working inside your computer, read the safety information that shipped with your computer. For additional safety best practices information, see the Regulatory Compliance Homepage at [www.dell.com/regulatory\\_compliance](http://www.dell.com/regulatory_compliance).

 **CAUTION:** Only a certified service technician should perform repairs on your computer. Damage due to servicing that is not authorized by Dell™ is not covered by your warranty.

 **CAUTION:** To avoid electrostatic discharge, ground yourself by using a wrist grounding strap or by periodically touching an unpainted metal surface (such as a connector on your computer).

 **CAUTION:** To help prevent damage to the system board, remove the main battery (see "Removing the Battery" on page 17) before working inside the computer.

## Display Assembly

### Removing the Display Assembly

- 1 Follow the instructions in "Before You Begin" on page 9.
- 2 Remove the base cover (see "Removing the Base Cover" on page 13).
- 3 Remove the battery (see "Removing the Battery" on page 17).
- 4 Follow the instructions from step 5 to step 16 in Removing the System Board.
- 5 Remove the six screws that secure the display assembly to the palm-rest assembly.
- 6 Note the routing of camera cable, display cable, and Mini-Card antenna cables and remove the cables from the routing guides.
- 7 Lift the palm-rest assembly away from the display assembly.

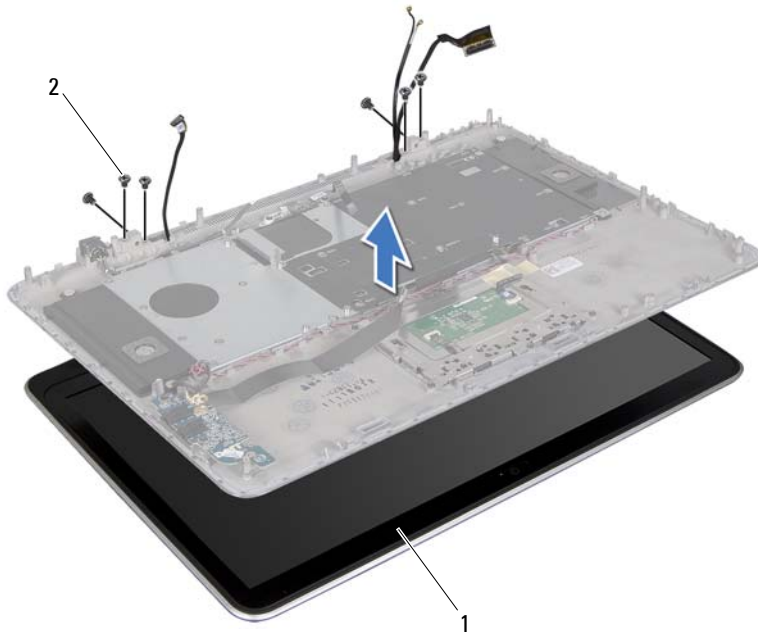

1 display assembly

2 screws (6)

## Replacing the Display Assembly

- 1 Follow the instructions in "Before You Begin" on page 9.
- 2 Place the palm-rest assembly on the display assembly and route the display cable, camera cable, and Mini-Card antenna cables through the routing guides.
- 3 Replace the six screws that secure the display assembly to the palm-rest assembly.
- 4 Follow the instructions from step 2 to step 12 in Replacing the System Board.

- 5 Replace the battery (see "Replacing the Battery" on page 18).
- 6 Replace the base cover (see "Replacing the Base Cover" on page 15).

 **CAUTION:** Before turning on the computer, replace all screws and ensure that no stray screws remain inside the computer. Failure to do so may result in damage to the computer.

## Display Bezel

### Removing the Display Bezel

 **CAUTION:** The display bezel is extremely fragile. Be careful when removing it to prevent damaging the bezel.

- 1 Follow the instructions in "Before You Begin" on page 9.
- 2 Remove the display assembly (see "Removing the Display Assembly" on page 81).

 **NOTE:** The display bezel surround cannot be reused. If either the display panel or the display bezel is replaced, use the display bezel surround provided in the kit.

- 3 Using your fingertips gently peel off the display bezel surround off the display bezel.

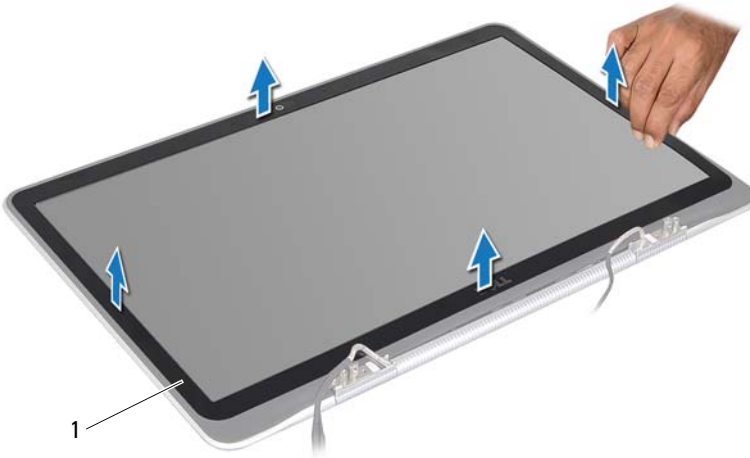

1 display bezel surround

- 4 Remove the four screws that secure the display bezel to the display back cover.
- 5 Lift the display bezel off the display assembly.

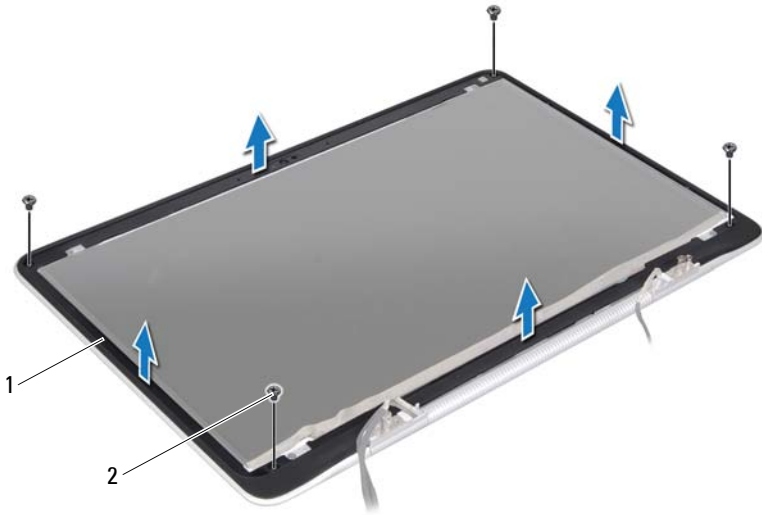

1 display bezel

2 screws (4)

## Replacing the Display Bezel

- 1 Follow the instructions in "Before You Begin" on page 9.
- 2 Align the display bezel with the display back cover and replace the four screws that secure the display bezel to the display back cover.
- 3 Adhere the display bezel surround along the display bezel.
- 4 Replace the display assembly (see "Replacing the Display Assembly" on page 82).



**CAUTION:** Before turning on the computer, replace all screws and ensure that no stray screws remain inside the computer. Failure to do so may result in damage to the computer.

# Display Panel

## Removing the Display Panel

- 1 Follow the instructions in "Before You Begin" on page 9.
- 2 Remove the display assembly (see "Removing the Display Assembly" on page 81).
- 3 Remove the display bezel (see "Removing the Display Bezel" on page 83).
- 4 Remove the four screws that secure the display panel to the display back cover.
- 5 Without pulling hard on the display panel, carefully lift the display panel and turn it over.



1 display panel

2 screws (4)

- 6 Gently peel off the display cable from the back of the display panel.
- 7 Pull the tape to disconnect the display cable from the connector on the display panel.



1 tape

2 display cable

- 8 Lift the display panel off the display back cover.

### Replacing the Display Panel

- 1 Follow the instructions in "Before You Begin" on page 9.
- 2 Connect the display cable to the connector on the display panel.
- 3 Adhere the display cable along the edge of the display panel.
- 4 Place the display panel over the display back cover.

- 5 Replace the four screws that secure the display panel to the display back cover.
- 6 Replace the display bezel (see "Replacing the Display Bezel" on page 85).
- 7 Replace the display assembly (see "Replacing the Display Assembly" on page 82).

## Display Hinges

### Removing the Display Hinges

- 1 Follow the instructions in "Before You Begin" on page 9.
- 2 Remove the display assembly (see "Removing the Display Assembly" on page 81).
- 3 Remove the display bezel (see "Removing the Display Bezel" on page 83).
- 4 Remove the display panel (see "Removing the Display Panel" on page 86).
- 5 Remove the eight screws (four on each side) that secure the display hinges to the display back cover.
- 6 Remove the display hinges off the display back cover.





- 1 display back cover                      2 screws (8)





## Replacing the Display Hinges

- 1 Follow the instructions in "Before You Begin" on page 9.
- 2 Place the display hinges in position.
- 3 Replace the eight screws (four on each side) that secure the display hinges to the display back cover.
- 4 Replace the display panel (see "Replacing the Display Panel" on page 87).
- 5 Replace the display bezel (see "Replacing the Display Bezel" on page 85).
- 6 Replace the display assembly ("Replacing the Display Assembly" on page 82).

**⚠ CAUTION:** Before turning on the computer, replace all screws and ensure that no stray screws remain inside the computer. Failure to do so may result in damage to the computer.



# Camera Module

-  **WARNING:** Before working inside your computer, read the safety information that shipped with your computer. For additional safety best practices information, see the Regulatory Compliance Homepage at [www.dell.com/regulatory\\_compliance](http://www.dell.com/regulatory_compliance).
-  **CAUTION:** Only a certified service technician should perform repairs on your computer. Damage due to servicing that is not authorized by Dell™ is not covered by your warranty.
-  **CAUTION:** To avoid electrostatic discharge, ground yourself by using a wrist grounding strap or by periodically touching an unpainted metal surface (such as a connector on your computer).
-  **CAUTION:** To help prevent damage to the system board, remove the main battery (see "Removing the Battery" on page 17) before working inside the computer.

## Removing the Camera Module

- 1 Follow the instructions in "Before You Begin" on page 9.
- 2 Remove the base cover (see "Removing the Base Cover" on page 13).
- 3 Remove the battery (see "Removing the Battery" on page 17).
- 4 Follow the instructions from step 5 to step 16 in Removing the System Board.
- 5 Remove the display assembly (see "Removing the Display Assembly" on page 81).
- 6 Remove the display bezel (see "Removing the Display Bezel" on page 83).
- 7 Remove the display panel (see "Removing the Display Panel" on page 86).
- 8 Disconnect the camera cable from the connector on the camera module.
- 9 Carefully lift the camera module off the display back cover.

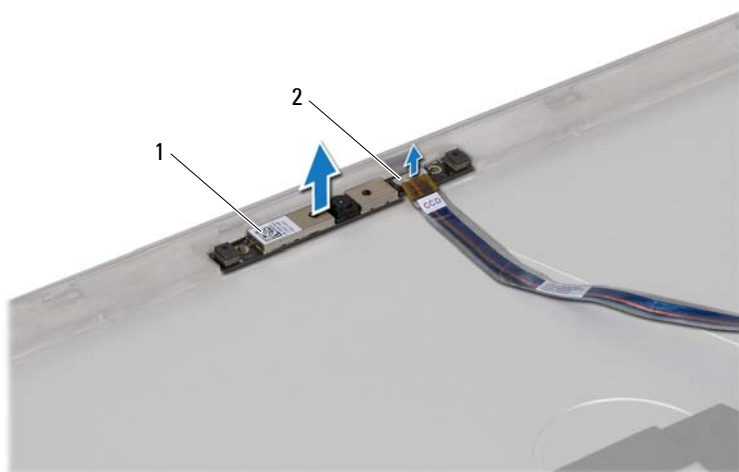

1 camera module

2 camera-cable connector

## Replacing the Camera Module

- 1 Follow the instructions in "Before You Begin" on page 9.
- 2 Connect the camera cable to the connector on the camera module.
- 3 Use the alignment posts to place the camera module on the display back cover.
- 4 Replace the display panel (see "Replacing the Display Panel" on page 87).
- 5 Replace the display bezel (see "Replacing the Display Bezel" on page 85).
- 6 Follow the instructions from step 2 to step 12 in Replacing the System Board.
- 7 Replace the display assembly (see "Replacing the Display Assembly" on page 82).
- 8 Replace the battery (see "Replacing the Battery" on page 18).
- 9 Replace the base cover (see "Replacing the Base Cover" on page 15).



**CAUTION:** Before turning on the computer, replace all screws and ensure that no stray screws remain inside the computer. Failure to do so may result in damage to the computer.



# Flashing the BIOS

The BIOS may require flashing when an update is available or when replacing the system board. To flash the BIOS:

- 1 Turn on the computer.
- 2 Go to [support.dell.com/support/downloads](http://support.dell.com/support/downloads).
- 3 Locate the BIOS update file for your computer:



**NOTE:** The Service Tag for your computer is located on a label at the bottom of your computer.

If you have your computer's Service Tag:

- a Click **Enter a Tag**.
- b Enter your computer's Service Tag in the **Enter a service tag:** field, click **Go**, and proceed to step 4.

If you do not have your computer's Service Tag:

- a Click **Select Model**.
- b Select the type of product in the **Select Your Product Family** list.
- c Select the product brand in the **Select Your Product Line** list.
- d Select the product model number in the **Select Your Product Model** list.



**NOTE:** If you have selected a different model and want to start over again, click **Start Over** on the top right of the menu.

- e Click **Confirm**.
- 4 A list of results appear on the screen. Click **BIOS**.
- 5 Click **Download Now** to download the latest BIOS file. The **File Download** window appears.
- 6 Click **Save** to save the file on your desktop. The file downloads to your desktop.
- 7 Click **Close** if the **Download Complete** window appears. The file icon appears on your desktop and is titled the same as the downloaded BIOS update file.

- 8 Double-click the file icon on the desktop and follow the instructions on the screen.